



# Ducerf Processed Wood 2<sup>nd</sup> transformation

*Ducerf group - Language* 



## *Customer relationship*

- An individual follow-up of sales in France and internationally.
- Quick answers to your questions and your needs from a dedicated support team.



## *Tools and technologies*

- A flexible production tool to meet specific demands.
- A continuous investment policy to stay ahead in a changing market.

## *Service*

- Very high reactivity thanks to a large stock.
- An expert team in international flow management.
- The provision of sales assistance tools.



## *Innovative, standard & tailored products*

- An R&D division at your service for collaborative development of innovative products.
- **For industry** (door and windows manufacturing): finger jointed or solid scantlings and door frames.
- **For interior design** (interior fittings, stairs, furniture, worktops, ...): a range of solid, finger jointed and three-ply panels.
- **For exterior design** (cladding, decking, public and private spaces, ...): a range of cladding and decking in THT wood or natural wood.



# Ducerf Processed Wood

Since 1962, the manufacturing unit of “Les Bois Profilés” is specialised in **second transformation**.

The main products of this Ducerf Group branch are panels and finger jointed scantlings, but it also offers a wide range of high-quality products, processed and treated with advanced technology equipment.

3

manufacturing sites in France: “Les Bois Profilés” (2 units) in Charolles (71), and “Bourgogne Bois Industrie” in Beire-le-Châtel (21)

14 500 m<sup>3</sup>  
of products per year

20 000 m<sup>2</sup>  
of sheds

13 500 m<sup>3</sup>  
of annual kiln drying capacity

Bois Profilés



La marque de la gestion forestière responsable

Discover our certified products FSC®

Bourgogne Bois Industrie



## Summary

Pages 4.5	<b>PANOLOT: solid panels</b>
Pages 6.7	<b>3 PLIS: three-ply panels</b>
Pages 8.9	<b>PATCHWOOD: finger jointed panels</b>
Pages 10.11	<b>PROFILEO: finger jointed or solid scantlings</b>
Pages 12.15	<b>COTEPARC: cladding</b>
Pages 16.20	<b>COTEPARC: decking</b>
Page 21	<b>Finishes for decking and cladding</b>
Page 22	<b>The Thermoprocess technology</b>





The Panoplot® is a ready-to-use panel made of solid full stave lamellas glued together on the side and in the width. It is intended for the manufacture of stair steps, tabletops, furniture, decoration, etc. It adapts to any common use of solid wood.



Natural Oak (RUSTIC)

## Advantages

- Ready to use
- Time saving / productivity gain
- Cost effective
- Drying guarantee
- High stability
- Optimised storage

## The product

- Lamellae with 40 mm and up
- Sanded on 2 faces
- Cut to available dimensions
- Individually wrapped with film
- PEFC™ or FSC® certification according to species

## Qualities

### Cabinet making oak:

tolerance of small sound integrated knots (diam. 5 mm max), panels in matching colour, sound sapwood admitted for back face

### Natural oak (Rustic):

filled sound knots, glued (diam. 25 to 30 mm max), panels in matching colour, sound sapwood admitted for back face

Beech: tolerance of traces of red heartwood on back face

### A/B oak:

Quality of Face A: QF1 Bis

Quality of Face B: QF1 Bis/QF2

### A/B ash:

Face A free of knots and 1 face clear

Face B, some knots allowed and all brown traces allowed

## Information

- Species: oak, unsteamed and steamed beech, ash
- All woods used are dried to 10% +/- 2%
- Gluing used D3 (for the interior)



## PANOLOT®

SPECIES	THICKNESSES	SOLD PER m <sup>2</sup>			
		19 mm	26 mm	31 mm	40 mm
	LENGTHS	WIDTH 950 mm*			
Cabinet making oak (1)	900 to 1600 mm**	•	•	•	•
	1800 to 2000 mm	•	•	•	•
	2200 / 2400 mm	•	•	•	•
Steamed beech A/B quality (1) or (2)	900 to 1600 mm**	•	•	•	•
	1800 to 2000 mm	•	•	•	•
	2200 / 2400 mm	•	•	•	•
Unsteamed beech A/B quality (1) or (2)	900 to 1600 mm**	•	•	•	•
	1800 to 2000 mm	•	•	•	•
	2200 / 2400 mm	•	•	•	•

SPECIES	THICKNESSES	SOLD PER m <sup>2</sup>	
		13 mm	
	LENGTHS	WIDTH	950 mm
Oak A/B quality	1200 / 1400 / 1600 / 1800mm		•
	2000 / 2200 / 2400 mm		

SPECIES	THICKNESSES	SOLD PER m <sup>2</sup>	
		19 mm	26 mm
	LENGTHS	WIDTH	1210 mm OR 950 mm subject to availability
Ash A/B quality***	1200 / 1400 / 1600 mm	•	•
	1800 / 2000 mm	•	•
	2200 / 2400 mm	•	•

SPECIES	THICKNESSES	SOLD PER m <sup>2</sup>			
		19 mm	26 mm	31 mm	40 mm
	LENGTHS	WIDTH 950 mm			
Natural Oak (1) (RUSTIC) ***	1400 / 1600 mm	•	•	•	•
	1800 mm	•	•	•	•
	2000 / 2200 / 2400 mm	•	•	•	•

\* Other widths on request - \*\* For 19 and 26 mm: lengths from 1400 mm only - \*\*\* Subject to availability

(1)



**PANOLOT orders must be made up of a variety of lengths (with the exception of 19 mm, which can be ordered in fixed lengths). Should lengths ordered be out of stock, similar lengths will be offered to the client.**

(2)



The mark of responsible forestry





# THREE-PLY PANELS

The 3 ply panel is of high quality, both from a technical and aesthetic aspect. It consists of continuous lamellas for the exterior sides and counter-crossed lamellas finger-jointed for the internal ply.

For manufacture of tabletops, furniture, decoration. It is designed to satisfy any common application of solid wood.

 **3PLIS**



## Advantages

- Very high stability
- Ready to use
- Time saving / Productivity gain
- Cost effective
- Drying guarantee
- Optimised storage

## The product

- **2-ply exterior:**  
full stave lamellas 80 or 140 mm in width, thickness 5 mm
- **1-ply interior:**  
counter-crossed lamellas finger-jointed, thickness 10 to 16 mm
- Sanded on 2 faces with 80 GR
- Individually wrapped with film
- FSC® panels certified

## Qualities

- A/B quality

## Information

- **Species:** oak, unsteamed beech, steamed beech, ash, maple, birch, alder, cherry, walnut
- All woods used are dried to 10% +/- 2%
- Gluing used D3 (for interior)



**3 ply panels — 20 mm thickness - 1250 mm width**

SPECIES / LENGTHS	SOLD PER m <sup>2</sup>						
	750/ 800/1000 mm	1250 mm	1650 mm	2050 mm	2300 mm	2500 mm	2700/3000 mm
Cabinet making oak	•	•	•	•	•	•	•
Natural Oak (RUSTIC)	•	•	•	•	•	•	•
Unsteamed or steamed beech	•	•	•	•	•	•	•
Maple	•	•	•	•	•	•	•
Birch - Alder	•	•	•	•	•	•	•
Ash	•	•	•	•	•	•	•
Walnut	•	•	•	•	•	•	

**3 ply panels — 26 mm thickness - 1250 mm width**

SPECIES / LENGTHS	SOLD PER m <sup>2</sup>	
	1250 / 1650 mm	2050 / 2500 mm
Oak	•	•
Unsteamed or steamed beech	•	•
Maple	•	•
Birch - Alder	•	•
Ash	•	•



Natural Oak (RUSTIC)

All panels are unit wrapped.



The mark of responsible forestry

FSC® on demand



Table "55" Tolix®







Patchwood® panels are made of finger-jointed lamellas in their length and laminated along the width. It is usually used for worktops, tabletops, furniture, interior decoration, and available in several sizes to meet all your interior design needs and requirements.



### Advantages

- Large sizes available: standard 4 m, up to 6 m
- Ready to use
- Time saving / Productivity gain
- Cost effective
- Drying guarantee
- High stability
- Optimised storage

### The product

- Lamellae width: 20 mm and 40 mm (+/- 2 mm)
- Cut to available dimensions
- Sanded on 2 faces
- Individually wrapped with film

### Quality

- A/B quality

### Information

- Species: oak, beech, maple, red exotic wood, walnut ...
- All woods used are dried to 10% +/- 2%
- Gluing used D3 (for the interior)





## PATCHWOOD®

20 mm Lamellae (+/- 2 mm) – Panel length 4000 mm – 650 or 950 mm width

SPECIES / THICKNESSES	SOLD PER m <sup>2</sup>				
	19 mm	26 mm	31 mm	40 mm	50 mm
Oak	•	•	•	•	•
Unsteamed beech	•	•	•	•	
Steamed beech	•	•	•	•	•
Ash	•	•	•	•	
Red exotic wood**	•	•	•	•	

\*\* In the limit of available stock

40 mm Lamellae – Panel length 4000 mm – 650 or 950 mm width

SPECIES / THICKNESSES	SOLD PER m <sup>2</sup>			
	19 mm	26 mm	31 mm	40 mm
Oak A/B quality	•	•	•	•
Unsteamed beech	•	•	•	•
Steamed beech	•	•	•	•

40 mm Lamellae width – Panel length 4500 mm – 1100 mm width

SPECIES / THICKNESSES	SOLD PER m <sup>2</sup>				
	18 mm	22 mm	33 mm	44 mm	56 mm
Rubberwood**	•	•	•	•	•

\*\* In the limit of available stock

**Tiles (beam)** – Length 4000 mm

SPECIES / THICKNESSES	SOLD PER m <sup>2</sup>	
	section 70 x 70 mm	section 90 x 90 mm
Rubberwood		

\*\* In the limit of available stock

**Worktop** – One edge rounded – Lamellae of 20 mm (+/- 2 mm) Width 650 mm

SPECIES	SOLD BY THE PIECE					
	THICKNESSES					
	26 mm		31 mm		40 mm	
	L.2000 mm <sup>(1)</sup>	L.4000 mm	L.2000 mm <sup>(1)</sup>	L.4000 mm	L.2000 mm <sup>(1)</sup>	L.4000 mm
Oak	•	•	•	•	•	•
Unsteamed beech	•	•	•	•	•	•
Steamed beech	•	•	•	•	•	•
Red exotic wood	•	•	•	•	•	•

(1) Sold only in sets of two

**Worktop** – One edge rounded – Lamellae of 40 mm (+/- 2 mm) Width 650 mm

SPECIES	SOLD BY THE PIECE					
	THICKNESSES					
	26 mm		31 mm		40 mm	
	L.2000 mm <sup>(1)</sup>	L.4000 mm	L.2000 mm <sup>(1)</sup>	L.4000 mm	L.2000 mm <sup>(1)</sup>	L.4000 mm
Oak			•	•	•	•



The Profileo® range, finger jointed or solid scantlings, is designed for doors and windows manufacturing. The following combinations are available allowing for cost effectiveness according to their use: visible joinery, 100% solid wood joinery, wood-aluminium windows...



FSC® on demand



## Advantages

- High stability
- Ready to use product
- Cost effective
- A number of quality combinations available: DKD, KKK...
- Certifications FSC® or PEFC™ according to species

## The product

- Solid or finger jointed layers
- Widths: 75 – 86 – 95 – 105 – 115 – 125 – 145 mm
- Thicknesses: 63, 72 or 84 mm depending on combinations
- Delivered S2S
- Planing, profiling, cutting to length on request

## Quality

- A wide choice of species, qualities and constructions according to end use (interior, exterior, to be painted or varnished)

## Information

- Glued according to standard DIN D4
- Certification of gluing CTB-Lca
- Moisture content 11% guaranteed (+ or - 2%)



## EUROPEAN OAK

DKD : 3 layers, external solid layers QF1a1 b, middle layer finger jointed QF1Axx

Widths	75 - 86 - 95 - 105 - 115 - 125 - 145 mm			Packaging
Thicknesses	63 mm (DKD) (21+21+21)	72 mm (DKD) (22+28+22)	84 mm (DKKD) (21+21+21+21)	Unique size per pallet with different lengths
Lengths (multiple 100 mm)	600 to 3000 mm			

KKK : 2 external layers finger jointed QF1a1b + 1 or 2 middle layer(s) finger jointed QF1Axx – S2S or 3 layers QF1Axx

Widths	75 - 86 - 95 - 105 - 115 - 125 - 145 mm			Packaging
Thicknesses	63 mm (KKK) (21+21+21)	72 mm (KKK) (22+28+22)	84 mm (KKKK) (21+21+21+21)	About 2 m <sup>3</sup> unique size per pallet
Lengths	4500 mm or 6000 mm (maxi)			

*Other sizes, qualities and compositions on request*

## US WHITE OAK

3 layers – external layers solid Prime grade – middle layer finger jointed or full length

Widths	75 - 86 - 95 - 105 - 115 - 125 - 145 mm			Packaging
Thicknesses	63 mm (DKD) (21+21+21)	72 mm (DKD) (24+24+24) or (22+28+22)	84 mm (DKKD) (21+21+21+21)	Consult us
Lengths (multiple 100 mm)	920 to 1830 mm / 2130 +			

## BROWN OAK

KKK: 3 layers finger jointed, same specification same as QF1a1b – S2S

Widths	75 - 86 - 95 - 115 - 125 mm			Packaging
Thicknesses	63 mm (KKK) (21+21+21)	72 mm (KKK) (22+28+22) or (24+24+24)	84 mm (KKKK) (21+21+21+21)	About 2 m <sup>3</sup> unique size per pallet
Lengths	4500 mm or 6000 mm (maxi)			

## LARCH

3 full length layers – external layers “ungraded” solid – middle layer 4 grade

Widths	95 - 120 - 140 mm			Packaging
Thicknesses	63 mm (DKD) (21+21+21)	72 mm (DDD) (21+30+21) or (22+28+22)	84 mm DDDD (21+21+21+21)	Consult us
Lengths	2700 to 5400 mm			

FSC® - other sizes on request

### **Other species and compositions on request:**

- **BEECH**  
KKK: 3 (or 4) layers finger jointed FF1AR, 4 faces planed
- **RED EXOTIC WOOD**  
KKK: lamellas finger jointed



# CLADDING

For tongue and groove or slotted cladding, consistent and durable species should be chosen, which are suited to the location and installation method.

**Côtéparc®** has selected local species to create a range of hardy, durable, ecological and aesthetically pleasing cladding products made of hard and soft woods, or thermo-treated (THT) wood.



Natural Oak QF2X



THT Ash A/B

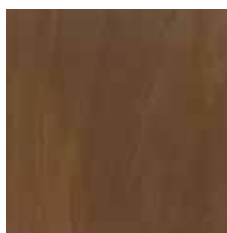

THT Poplar A/B

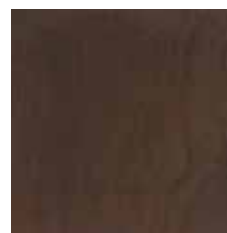

THT Oak QF2X

## THT Advantages

- Increased durability
- Resistant to insects and fungal attack
- Greater dimensional stability
- Local wood species
- 100% natural materials and treatment
- Develops a homogenous grey colouring
- Can be finished

## The product

- Natural or thermo-treated wood cladding
- 7 product profiles from standard to highly bespoke, tongue and groove or clerestory type
- Full length or finger jointed boards
- Jointing compliant with DTU
- MUF ply gluing available (exterior)
- Made to order profiles available (subject to project assessment)

## Species

- Hardwoods: Oak THT, Ash THT, Poplar THT, Natural Oak
- Other species on request



## BEVELED LINE PROFILED CLADDING

SPECIES	THICKNESSES	TOTAL WIDTH	VISIBLE WIDTH	SOLD PER m <sup>2</sup> (ACTUAL USABLE SURFACE AREA)	
				Full length boards	Finger jointed boards
THT Oak QF2 X	21 mm	120 mm	110 mm	•	
		140 mm	130 mm	•	
THT Ash A/B	21 mm	120 mm	110 mm	•	
		140 mm	130 mm	•	
THT Poplar A/B	21 mm (solid) ou 19 mm (finger jointed)	120 mm	110 mm	•	•
		140 mm	130 mm	•	•
Natural OAK QF2 X	21 mm (solid) ou 19 mm (finger jointed)	120 mm	110 mm	•	•
		140 mm	130 mm	•	•
Maritime pine THT OA	21 mm	135 mm	125 mm	•	

### Packaging:

#### Full length boards:

- variety of lengths from 800 to 2400 mm or 3000\* mm (\*for poplar only), 200 by 200 (20% less than 2000 mm),
- maritime pine THT OA: from 800 to 2000 mm (15% of lengths less than 2000 mm).

#### Finger jointed boards:

3000 to 5000 mm delivered with excess length (length of elements from 250 to 900 mm).

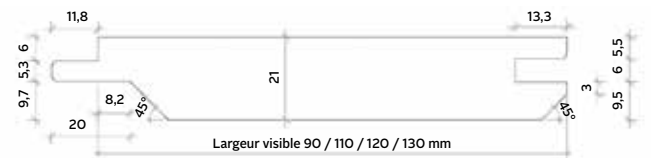

## CORNER PROFILE

Compatible with beveled line profiled / BARD 100 to 104

Lengths subject to availability

SPECIES	THICKNESSES	WIDTHS	SOLD BY THE L.m (linear metre)
THT Poplar profile	66 mm	66 mm	•
Natural oak profile	66 mm	66 mm	•

Technical procedure to achieve compound inner or outer corner:

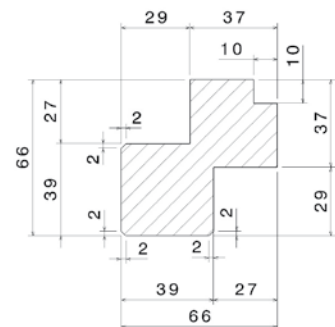



Bard 105 in thermo treated poplar



Bard 104 in thermo treated poplar



Aquatic centre la Palestra





Thermo treated Ash Cladding - Emeline Poulain Architect



Thermo treated poplar cladding - Tybivouac



Thermo treated poplar cladding - Gauthier transports



# CLADDING

Some unusual ideas for cladding in THT wood...  
in various profiles and species, to make your vision a reality.

Flat profile  
**BARD 100**

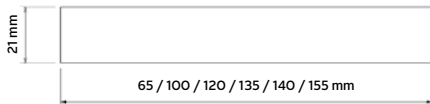

Parallelogram profile  
**BARD 101**

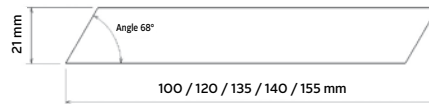
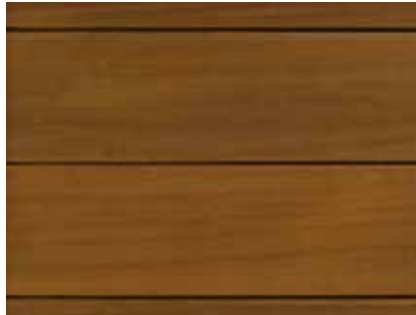

Clerestory cladding profile  
**BARD 102**

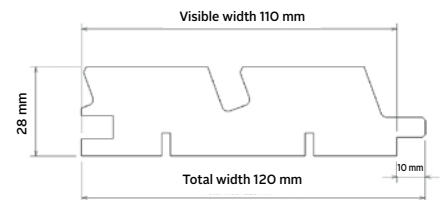

**Full length boards:**

- Variety of lengths from 800 to 2400 mm or 3000\* mm (\*for poplar only), 200 by 200 (20% less than 2000 mm),
- Maritime pine THT OA: from 800 to 2000 mm (15% of lengths less than 2000 mm).

**Finger jointed boards:** 3000 to 6000 mm delivered with excess length (length of elements from 250 to 900 mm).

REFERENCES	SPECIES	THICKNESSES	TOTAL WIDTH	SOLD BY m <sup>2</sup> (ACTUAL USABLE SURFACE AREA)	
				Full length boards	Finger jointed boards
BARD 100 BARD 101 BARD 103 (1)	THT OAK QF2 X	21 mm	120 mm	•	
			140 mm	•	
	THT Ash A/B	21 mm	120 mm	•	
			140 mm	•	
	THT Poplar A/B*	21 mm (solid) ou 19 mm (finger jointed)	65 mm (BARD 100 only)	•	•
			120 mm	•	•
140 mm			•	•	
Maritime pine THT OA	21 mm	135 mm	•		
BARD 102 (2)	THT Poplar A/B*	28 mm	120 mm (110 visible)	•	•
BARD 104 (2)	THT Ash A/B	21 mm	120 mm (110 visible)	•	
	Maritime pine THT OA		135 mm (125 visible)	•	
	THT Poplar A/B*	21 mm (solid) ou 19 mm (finger jointed)	140 mm (130 visible)	•	•

(1) Straight cut at edge - For BARD 100 and BARD 103 tongue and groove at edge on request  
(2) Tongue and groove at edge





Rounded profile  
**BARD 103**

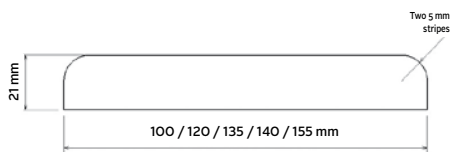

Vertical clerestory cladding  
profile **BARD 104**

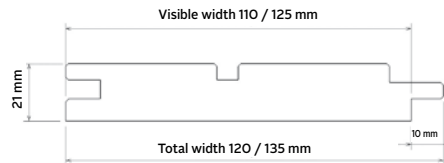

Rectangular profile  
**BARD 105**

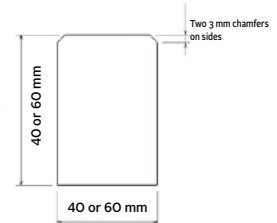
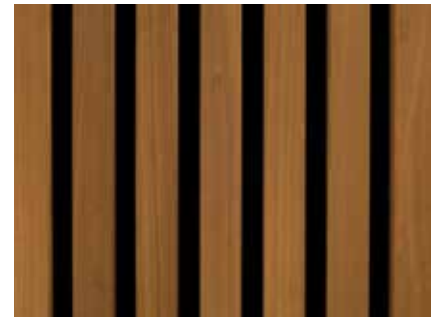

**Full length boards:**

- THT Poplar 1200, 1800, 2400 mm and 3000 mm,
- Maritime pine THT OA: 800, 1400 and 2000 mm.

**Finger jointed boards:** 3000 to 6000 mm delivered with excess length (length of elements from 250 to 900 mm).

REFERENCE	SPECIES	THICKNESSES	TOTAL WIDTH	SOLD BY Lm (linear metre)	
				Full length boards	Finger jointed boards
BARD 105	THT Poplar A/B	40 or 60 mm	60 or 40 mm	•	•
		40 mm	40 mm	•	•
	Maritime pine THT OA	40 or 60 mm	60 or 40 mm	•	•
		40 mm	40 mm	•	•
	Natural OAK QF2	40 mm	40 mm		•





# CLADDING

## BARD 106 FINITION CARBON

The Bard 106 carbon finish is a thermo-treated poplar cladding with a modern look, rough sawn and with an Intense Black finishing.

A new jointed profile has been specially developed to give a uniform appearance to the cladding and allow invisible fixing.



### Jointed Profile BARD 106

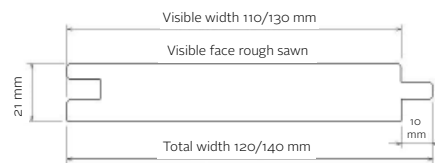

REFERENCE	SPECIES	THICKNESS	TOTAL WIDTH	SOLD BY m <sup>2</sup> (ACTUAL USABLE SURFACE AREA)
BARD 106 CARBON	THT Poplar	21	140 mm	•

### CORNER PROFILE

Compatible with beveled line profiled / BARD 100 to 104  
Lengths subject to availability

SPECIES	THICKNESS	WIDTH
THT Poplar profile	66 mm	66 mm

## Advantages

- New: Jointed profile BARD 106
- Visible face rough sawn
- New finish colour
- Ecological saturator for a ready-to-use product
- Thermo-treated wood cladding
- Light and design
- Increased durability
- Greater dimensional stability
- Local species
- Material and treatment 100% natural
- Long life finishing

## The product

- Available in full lengths boards (Variety of lengths : 800, 1200, 1600, 2000, 2400, 3000 mm)
- A/B quality
- Visible sections : 21 x 110mm et 21 x 130mm
- Thickness : 21 mm
- Processing : Visible face rough sawn, 2 beveled edges, planed back faces, 2 tongue and groove edges.



## BARD 107 TEXTURE

Bard 107 Texture is a wall cladding solution with a structured surface and a sensory design pattern.

Modern and trendy, this range of profiled boards will give a new dimension to your interior design projects.



Bard 107 Texture, natural oak QF2

## Advantages

- 100% natural wood interior design product
- Unique structured surface finish
- Inspired by nature
- Easy to install and maintain
- Fits in with all decorative styles
- Ideal for adding character to a room, for delimiting without partitioning or for adding a natural decorative touch
- Local wood species
- Design and aesthetics

## The product

- Available as continuous boards (a range of lengths: 800, 1200, 1600, 2000, 2400mm) or finger-jointed boards (lengths on request)
- Processing: structured face, 2 chamfered edges, planed counter faces with stress relief grooves, 2 profiled edges, end tongue groove.

## Jointed profile BARD 107

positioning of the fastener

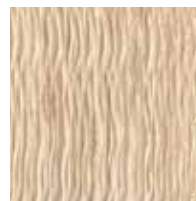
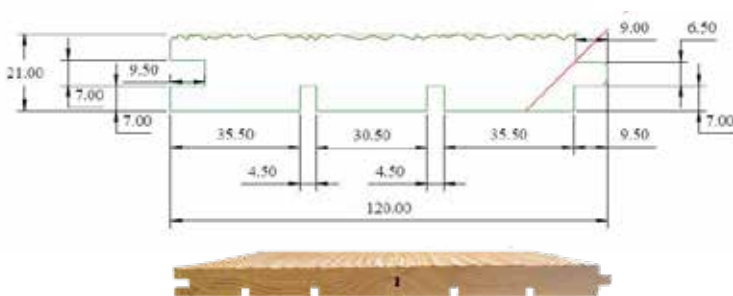

Natural Oak



THT Poplar

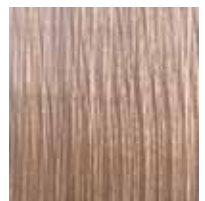

THT Ash

SPECIES	THICKNESSES	TOTAL WIDTH	VISIBLE WIDTH	INDICATIVE SELLING PRICE HT / m <sup>2</sup> ACTUAL USABLE SURFACE AREA	
				Full length boards	Finger jointed boards
Natural Oak QF2	19 mm (finger jointed)	110 mm	100 mm		•
Natural Oak QF2X	21 mm (solid)	120 mm	110 mm	•	
		140 mm	130 mm	•	
THT Poplar	19 mm (finger jointed)	140 mm	130 mm		•
	21 mm (solid)	120 mm	110 mm	•	
		140 mm	130 mm	•	
THT Ash	19 mm (finger jointed)	140 mm	130 mm		•
	21 mm (solid)	120 mm	110 mm	•	
		140 mm	130 mm	•	



**CôtéParc®** decking offer several technical, aesthetic and environmental benefits thanks to the use of local woods and Thermoprocess® treatment.

By using the right species in the right place, the wood continues to provide durability in the face of time and weather for many years.



## Advantages

- Ready to use
- Local species
- Natural hardness of hard and soft woods
- Develops a homogenous grey colouring
- Resistant to insects and fungal attack
- Exceptional durability
- Greater dimensional stability
- 100% natural materials and treatment
- Can be finished

## The product

- Natural ou thermo-treated wood decking
- Local species
- Choice of smooth or grooved boards
- Full stave or finger jointed boards
- Staves cut along the length
- Standard or invisible fixings

## Species

- Natural oak without sapwood
- THT Ash
- Natural Acacia
- Douglas free of sapwood
- Grey autoclaved Douglas
- Other species on request

## Information

- PU finger jointed (exterior)
- Choice A/B: A being the reference side



Natural Oak QF2 without sapwood



THT Ash



Natural Acacia



Douglas free of sapwood



Grey autoclaved Douglas



## DECKING PROFILES

Smooth/grooved – Standard fixing / Invisible fixing B-Fix® (on request)

**Full stave boards** : 800 - 1200 - 1600 - 2000 - 2400 mm

Acacia : 1000 - 1500 - 2000 - 2500 mm - Douglas : 4000 mm

**Finger jointed boards** : 3000 to 6000 mm (*length of elements from 250 to 900 mm*)

**Packaging** : Variety of lengths (20% less than 2000 mm) and fixed lengths for Douglas.

SPECIES	THICKNESSES	TOTAL WIDTH	SOLD PER m <sup>2</sup>	
			Lengths Full stave boards	Lengths Finger jointed boards**
Natural Oak QF2* without sapwood	21 mm	120 mm	•	•
		140 mm	•	•
THT Ash A/B (1)	21 mm	120 mm	•	
		140 mm	•	
Natural Acacia A/B (1)	21 mm	100 mm	•	•
		120 mm	•	•
Untreated Douglas free of sapwood*	27 mm	145 mm	•	
Grey autoclaved Douglas*	27 mm	145 mm	•	
Maritime pine THT OA	21 mm	135 mm	•	

\* Smooth face visible – only available for standard fixings - \*\* Minimum order volume 1000 ml (*length of elements from 250 to 900 mm*)

(1) A/B choice: A is the reference face

### Decking profile according to fixing type

Smooth face, standard fixing



Smooth face, invisible B-Fix® fixing



Grooved face, standard fixing

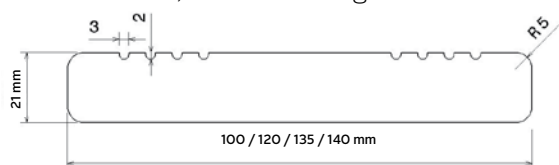

Grooved face, invisible B-Fix® fixing

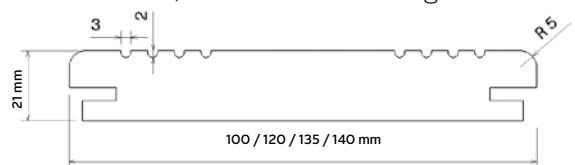

**\*\* new on demand**

Length 120 mm / Thickness 21 mm  
standard or invisible fixing

Curved decking smooth face

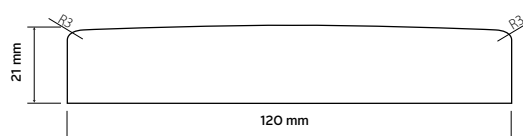



# DECKING

## BATTENS

SPECIES	LENGTHS	WIDTHS	THICKNESSES	SOLD BY Lm (linear metre)
Natural Oak without sapwood	2000 / 2500 3000 mm	65 mm	45 mm	
Autoclave Soft wood (PINE CL4)	4500 /5000 mm	70 mm	45 mm	



Other sections available, please ask us



"Hôtel de la Poste" Charolles - Ash decking THT





Thermo treated ash decking

## B-FIX® INVISIBLE FASTENING SYSTEM



Invisible fixing for decking of 21 mm thick. An impeccable finish, quick and easy to install, always removable, even center planks.

PACKAGE CONTENT		QUANTITY REQUIRED	SOLD BY BOX
Bronze border finish 	50 pieces per box	20 Lm of border per box	
Black fixing 	100 B-Fix® One (stainless steel 301) / 100 B-Screws / 1 Torx Bit / For 5 to 6 m² / 1 instructions notice	4.8 m² /box width 120 mm and 5.6 m² /box width 140 mm	

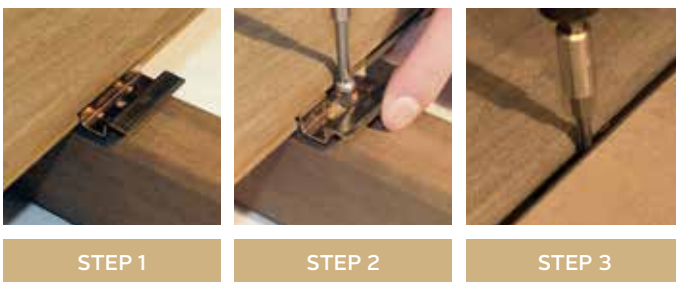

Ash decking THT, IPE look finish Saturabois®, B-Fix® invisible fixing





Casa Park Lucia - Ash decking THT, B-Fix® invisible fixing



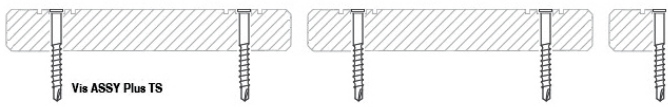





## STANDARD FIXING SYSTEM

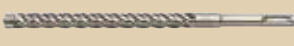

PRODUCT		DIAMETER (mm)	LENGTH (mm)	PIAS	QUANTITY IN BOX	SOLD BY BOX
	Special A2 stainless hardwood screw	5	60	AW 25	100	
	A2 stainless double threaded screw for optimum anchoring with rounded and milled head	5.5	60	AW 20	250	
	A2 stainless self-tapping wood screw with under-sized rounded head and reinforced annealed barrel	5.5	40	AW 20	250	
		5.5	60	AW 20	250	
		5.5	90	AW 20	100	

## OTHER ACCESSORIES

PRODUCT	FEATURE	QUANTITY IN BOX	SOLD BY BOX
 Separating shim (only for standard fixing)	The snake-form separating shims create a gap between the joist and the decking board: • prevent humidity stagnating and the wood from distorting prematurely, • allow the underface of the decking boards to ventilate. Dimensions: length 345 mm x width 17.5 mm x height 8 mm	50	
	PIAS AW 20	1	
	PIAS AW 25	1	
	PIAS AW 30	1	
	Special screw to fix joist directly in concrete slab without sleeve with 6.5 mm Ø drill cavity. Dimension: 7.5 x 112 mm / Pias AW 30	100	
	Concrete drill bit for joist screw Dimension 6.5 x 210 mm SDS Plus fitting	2	
	Fork shims to separate joist from concrete slab. Dimensions: 1/2/3/4 and 5 mm x 36 mm x 40 mm Box of 1000 shims contains: 200 1 mm thick / 200 2 mm thick / 200 3 mm thick / 200 4 mm thick / 200 5 mm thick	1000	
	Enables regular pre-drilling of holes in decking boards: neat and easy work, perfect screw alignment	1	
	Flush cutting bit with milling component and depth guide. The integrated milling component mills a cavity which ensures the screw head is flush with the board, bit Ø 4 mm	1	





## STUDS

When installing wooden decking on a stable foundation (concrete slab, compacted gravel ground, etc.) we advise the use of adjustable studs.



28 to 965 mm  
**adjustable studs**

						
ITEM CODE	PB-01	PB-1	PB-2	PB-3	PB-4	PB-5
ADJUSTABLE HEIGHT	28-42 mm	42-60 mm	60-90 mm	90-145 mm	145-245 mm	245-315 mm
QUANTITY REQUIRED (number of studs per m <sup>2</sup> )	Between 4 and 6 studs per m <sup>2</sup> according to type of decking and joist. Ask our advice.					
SOLD INDIVIDUALLY	Ask our advice					

						
ITEM CODE	PB-6	PB-7	PB-8	PB-9	PB-10	PB-11
ADJUSTABLE HEIGHT	285-367 mm	365-485 mm	452-605 mm	537-725 mm	620-845 mm	705-965 mm
QUANTITY REQUIRED (number of studs per m <sup>2</sup> )	Between 4 and 6 studs per m <sup>2</sup> according to type of decking and joist. Ask our advice.					
SOLD INDIVIDUALLY	Ask our advice					

## ACCESSORIES



Thickness of BC-PH-5 = +12 mm, in addition to the adjustable height of the stud

Height: 12 mm

### BC-PH-5 slope corrector

Placed on the underside of stud. Composed of 2 cylindrical parts, it compensates for slopes of 1 to 5% simply by rotating these parts.

**SOLD INDIVIDUALLY**

(Ask our advice)



**KIT-5 Support for standard wooden joist**

**SOLD INDIVIDUALLY**

(Ask our advice)



# FINISHES DECKING-CLADDING

To maintain, protect and rejuvenate exterior THT wood, we recommend a range of saturators that are easy to apply, durable and easily maintained.

## Application in our FACTORY for a ready-to-use product:

Water-based saturator.

Available shades: clear, THT wood stain, grey.

## MANUAL application by THE USER:

SATURABOIS® uses molecular association technology:

- made with natural ingredients
- protects all species of wood: hardwood, softwood, autoclaved and thermo-treated woods (THT\*)
- only one coat is required
- contains latest generation of UV Stabilisers
- contains anti-blackening molecules
- easy to apply (without jointing or attaching)
- cost effective
- easy to maintain, does not flake... no more sanding!

\* THT= thermo-treated wood, called also heat treated wood (a high temperature treated process)

## WOOD TRENDS THT wood colour chart

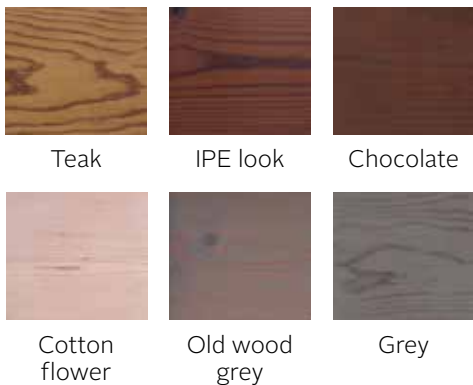

## COLOUR TRENDS THT wood colour chart

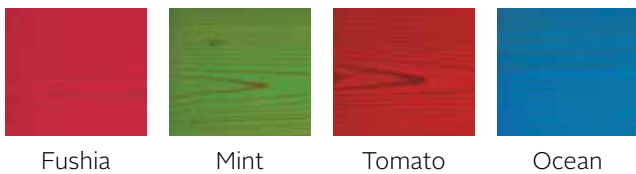

(Pictures and colours are not binding)



	APPLICATION OF FINISH
On CLADDING: Beveled LINE PROFILED / BARD 100 / BARD 101 / BARD 102 /BARD 103 / BARD 104	On cladding face and profile edges
BARD 105	Select from: On cladding face and profile edges On all profile faces
On CORNER PROFILES	On all profile faces
For DECKING	On cladding face and profile edges

## Factory application for a ready-to-use product

Water-based saturator (colourless, THT wood stain, grey)

### CLADDING

Application on the face of the profile and edges of the profile

			Supplement to be added to the indicative sales price excluding VAT/m <sup>2</sup>		
Ref. / Species	Thickn.	Total width	25 - 50 m <sup>2</sup>	50 - 150 m <sup>2</sup>	more than 150 m <sup>2</sup>
with production start-up package					

#### ÉLÉGIE / BARD 100 / BARD 101 BARD 102 / BARD 103 / BARD 104

Ref. / Species	Thickn.	Total width	25 - 50 m <sup>2</sup>	50 - 150 m <sup>2</sup>	more than 150 m <sup>2</sup>
Oak THT QF2X Ash THT A/B Poplar THT A/B Natural Oak Maritime Pine THT OA	21 mm or 28 mm depending on the profile	65 - 100 120 - 135 - 140 155 mm depending on the species & the profile	•	•	•

#### BARD 105

			Supplement to be added to the indicative sales price excluding VAT/ml		
Ref. / Species	Thickn.	Total width	200 - 400 ml	400 - 1250 ml	more than 1250 ml
with production start-up package					

Application on the face and edges of the profile

Ref. / Species	Thickn.	Total width	200 - 400 ml	400 - 1250 ml	more than 1250 ml
Poplar THT A/B Maritime pine THT OA	60 mm 40 mm	40 mm 40 mm	• •	• •	• •

Application on all sides of the profile

Ref. / Species	Thickn.	Total width	200 - 400 ml	400 - 1250 ml	more than 1250 ml
Poplar THT A/B Maritime pine THT OA	60 mm 40 mm	40 mm 40 mm	• •	• •	• •

### CORNER PROFILES

Application on all sides of the profile

			Supplement to be added to the indicative sales price excluding VAT/ml		
Ref. / Species	Thickn.	Total width	200 - 400 ml	400 - 1250 ml	more than 1250 ml
Oak THT Ash THT Poplar THT Natural Oak	66 mm	66 mm		•	

### DECKING

Application on the face of the profile and edges of the profile

			Supplement to be added to the indicative sales price excluding VAT/m <sup>2</sup>		
Ref. / Species	Thickn.	Total width	25 - 50 m <sup>2</sup>	50 - 150 m <sup>2</sup>	+ de 150 m <sup>2</sup>
with production start-up package					

Ref. / Species	Thickn.	Total width	25 - 50 m <sup>2</sup>	50 - 150 m <sup>2</sup>	+ de 150 m <sup>2</sup>
Natural Oak QF2 no sapwood Ash THT A/B Maritime Pine THT OA Natural acacia A/B Natural Douglas Fir without sapwood	21 mm or 27 mm depending on the profile	100-120-135 140-145-155 mm depending on the species & the profile	•	•	•



# OAK DECKING

For outdoor use, oak is king. This reliable material enhances any landscaping while guaranteeing excellent quality and durability. The Ducerf Group's oak decks are especially popular for building footpaths, pontoons, decking or public walkways. For increased flexibility, these are available in the rough, planed or planed/grooved.

## The product

- **PREMIUM Oak decking**
- **Limited sound knots to half the width of the board**
- **No knots on edges**
- **Except sapwood**
- **Core heart traces tolerance (on the back side)**
- **Stamp custom-sized 1 to 2 cm**
- **Wood dried to 25/30%**

## Advantages

- **Ready to use**
- **Local species**
- **Natural hardness of hard and soft woods**
- **Can be finished**





# PREMIUM OAK DECKING



Lengths : 2000 to 3000 mm

SECTION (mm)	PLANED		PLANED + SQUARE CUT	
	135	45	135	45

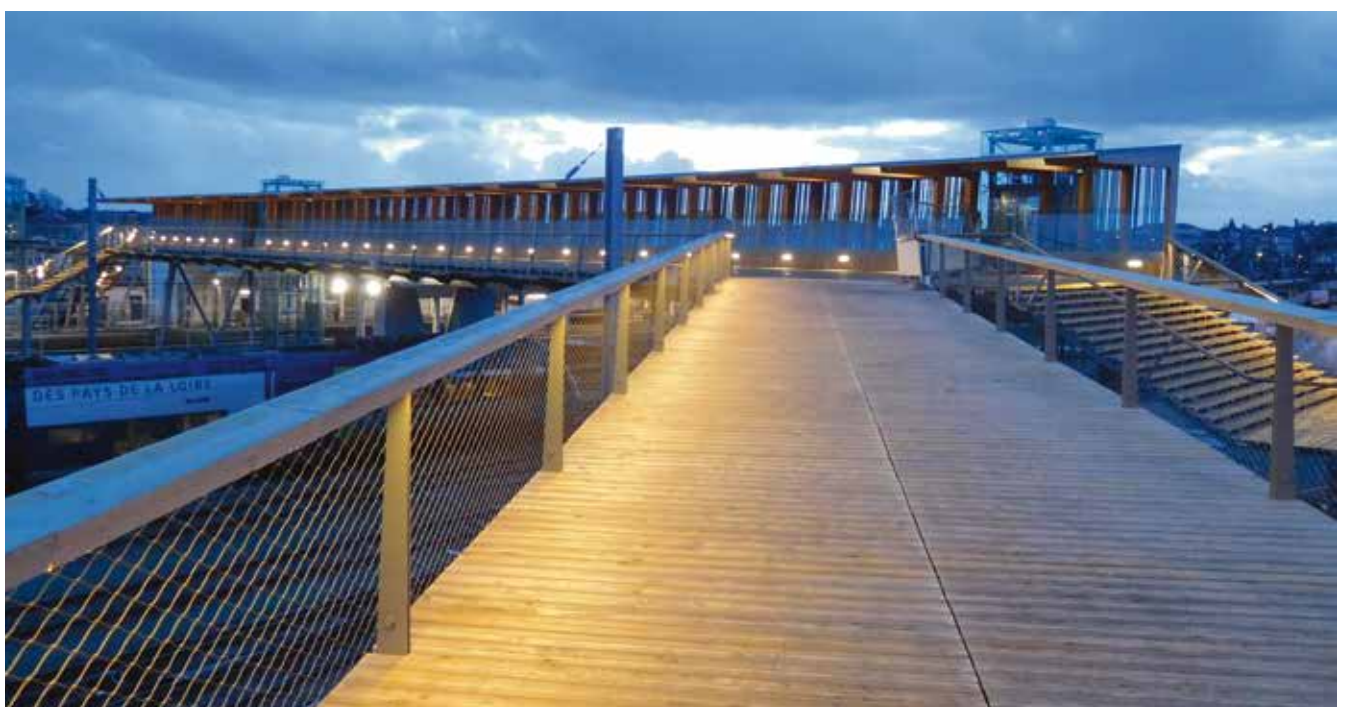



Innovation is an important division within the DUCERF group: a range of exterior decking and cladding products of high temperature treated wood has been developed using the THERMOPROCESS® process.



## PRINCIPLE

The Thermoprocess thermal modification process uses high temperatures and a controlled oxygen and humidity atmosphere in order to modify permanently physical and chemical properties of wood. This molecular modification of wood is intended to make it more durable without any chemical product addition. The “cooking” leads to degradation of hemicelluloses, crosslinking of the lignin polymer network, and increase of cristallinity. The material is thus less hydrophilic and less subject to dimensional changes due to variations of moisture content (warp, twist or torsion). Deprived of its sugars compound, heat-treated wood is also less sensitive to insects or fungi attacks. Caramelized color obtained will gradually move to a homogeneous silver grey tone. Thanks to this process local wood with natural low durability can be used in outdoor condition preventing the importation of tropical hardwood species.

## PROCESS STEPS

- 1. Increasing temperature:** temperature is quickly increased up to 100 °C with steaming. Wood is then dried slowly between 100 and 130 °C. Steam and low oxygen amount in the atmosphere prevent from cracks formation and help chemical reaction to occur. At the end of this step, wood moisture content is about 0%. The proper management of this stage is essential for wood modification. Its length depends on various parameters such as initial moisture content, wood species and dimensions of timbers.
- 2. High temperature treatment:** chemical modifications of wood take place above 150 °C. Temperature is brought in the kiln between 160 and 230 °C and kept constant for 1 to 2 hours depending on the desired properties.
- 3. Cooling and rewetting:** during this last step, the decrease of temperature is supported by water-spraying. A slight moisture uptake occurs around 90 °C. The length of this stage is between 5 and 15 hours depending on the treatment conditions and desired properties.

## Heat-treated wood properties

- Improved resistance to fungal attacks
- Equilibrium moisture content reduced by 50%
- Better dimensional stability
- Density reduced by 10%
- Darker color in the mass
- Thermal conductivity reduced between 10 and 30%
- Reduction of extractive amount (tannin, resin)
- Increased rigidity
- Decreased bending strength
- Suitable for gluing

## Heat-treated wood use

- Housing
- Cladding
- Decking
- Flooring
- Shutters
- Doors and windows frames
- Joinery
- Interior design
- Outdoor furniture
- Layout

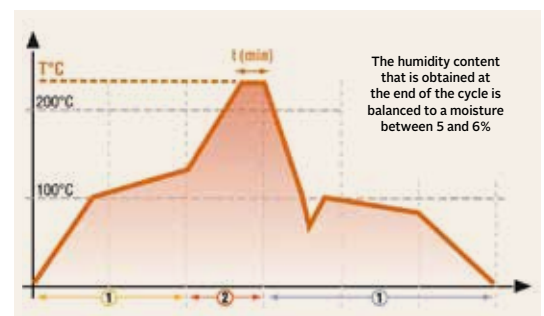





## INSTRUCTIONS FOR USE PANOPLAT, PATCHWOOD & 3 PLIS

### To read first

The panels are only intended for interior use where contact with splash water or condensation is very short term.

Wood is subject to dimensional movements (shrinkage/swelling) due to changes in humidity.

In order to prevent this, the following recommendations must be observed.

### Storage

Store the filmed panels flat on top of each other in a dry, closed room. Insulate them from the ground by laying them on battens spaced 1 m apart and orientated in the direction of the width.

Only remove the plastic film when applying the finish.

### Cut outs

Leave a minimum of 20 cm between two cuts and 10 cm from the longitudinal edge in the panel.

### Finishing

Apply the appropriate finish for the purpose before installation and assembly of the panels with a minimum of two coats.

Apply an identical finish (volume of product and number of coats) to each side and edge to balance the moisture content of the panel.

For an oiled or varnished finish, apply the same number of coats on each side and edge at the same time to balance out the worktop.

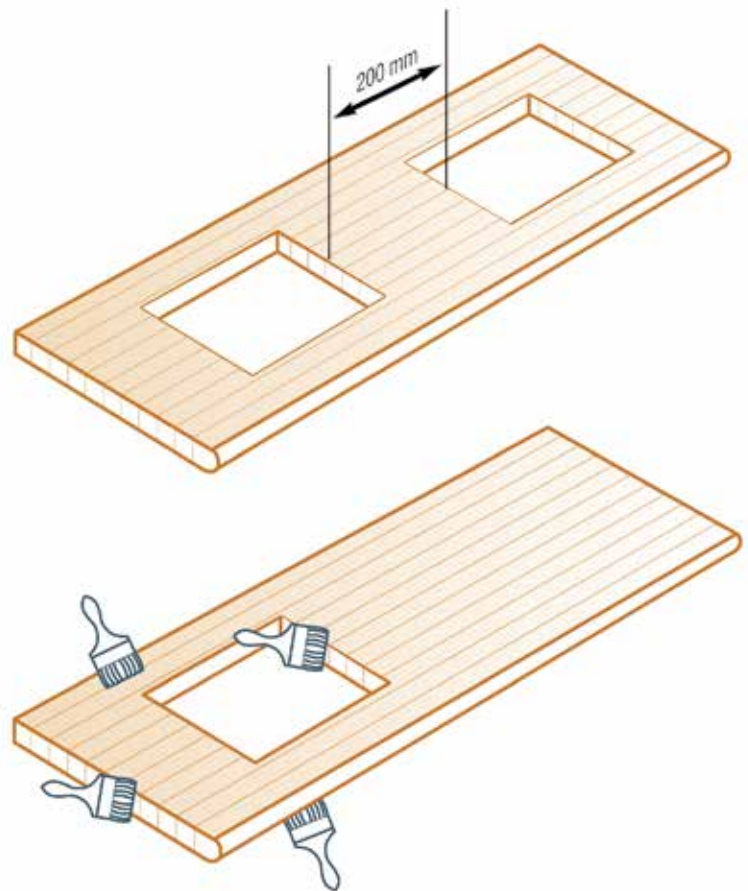

### BEWARE !

Appliances that generate heat (pans, etc.) must not be placed directly on the panels.  
Use a heat-resistant insert (trivet, etc.).

The adhesives used for the manufacture of the panels are classified as DIN D3, panels for interior use only.

## GENERAL INSTALLATION SPECIFICATIONS

Dimensional variations can occur mainly in the width and thickness of the worktop. It is therefore necessary to leave an expansion gap at the various fixing points. Furthermore, the panel must not rest directly on a solid support, it is imperative to leave a gap of 3 to 5 mm between the panel and the walls.

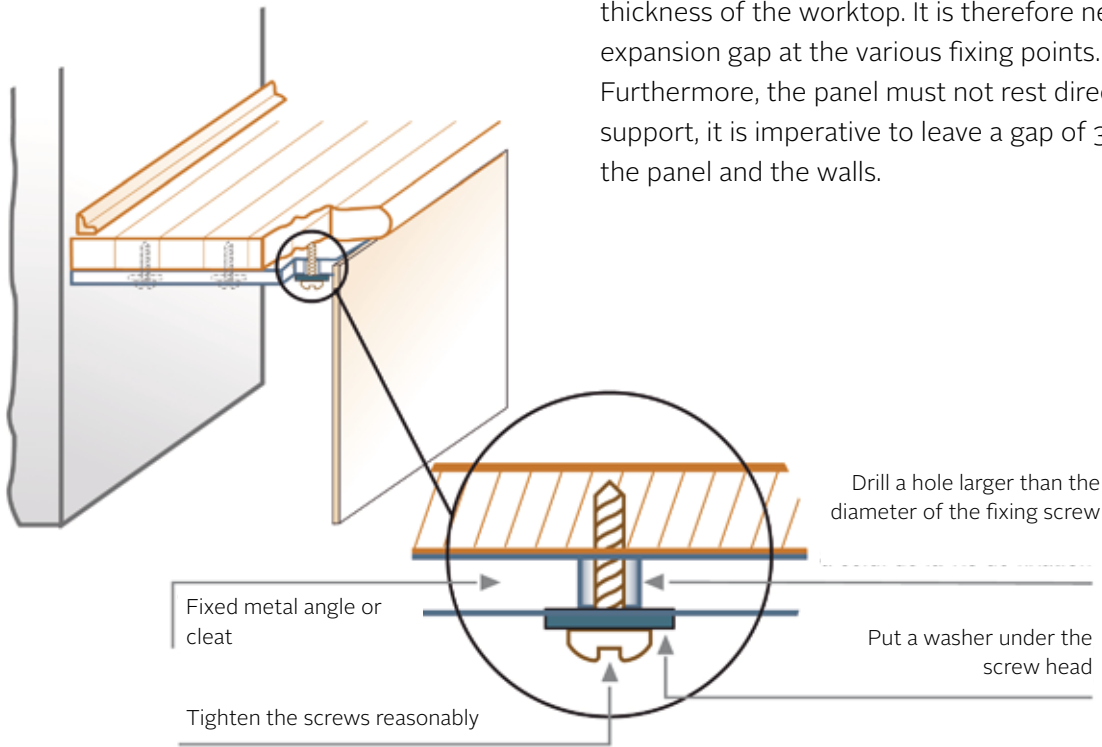

### SPECIFIC INSTALLATION TIPS PANOPLOT & PATCHWOOD

If the panel is to be screwed in place, a hole larger than the diameter of the screw should be drilled in the support part so that the panel can absorb the dimensional movements.

For use as a work surface, leave a gap of 3 to 5 mm between the panel and the wall.

Apply a silicone-type sealant to fill the gap..

#### Screw fixing

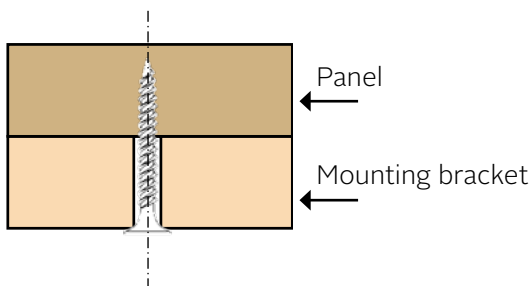

### SPECIFIC INSTALLATION TIPS 3 PLIS

In cupboard doors, if the width of use is greater than 35 cm, it is recommended that a frame be fixed to the back or around the 3-ply panel. Below is a suggested application for wall cladding.

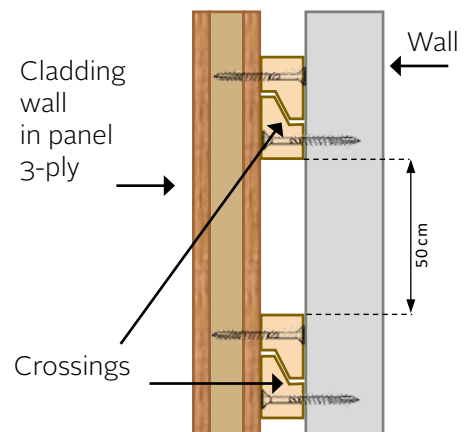

#### USE

Depending on the use and the finish applied, provide adequate maintenance.





## CLADDING

For standard profiles only, other cases: consult us.

The installation advice given above is indicative and non-contractual: it is a matter of usual and general rules to be respected, but it is not exhaustive; these rules must be completed and adapted on a case-by-case basis, according to the precise environment in which the products will be used. Installation by the customer assumes that he/she has the minimum technical skills to do so; if this is not the case, and in the event of any doubt or difficulty whatsoever, it is the customer's responsibility to consult a professional or your sales advisor before any intervention.

### The different roles of wood cladding:

- Aesthetic role: exterior finish of a building,
- A mechanical role: to guarantee resistance to impact and friction,
- A functional role: guaranteeing watertightness thanks to the rain screen, reinforcing the thermal resistance of the wall thanks to the thermal insulation provided by the wood and the air gap.

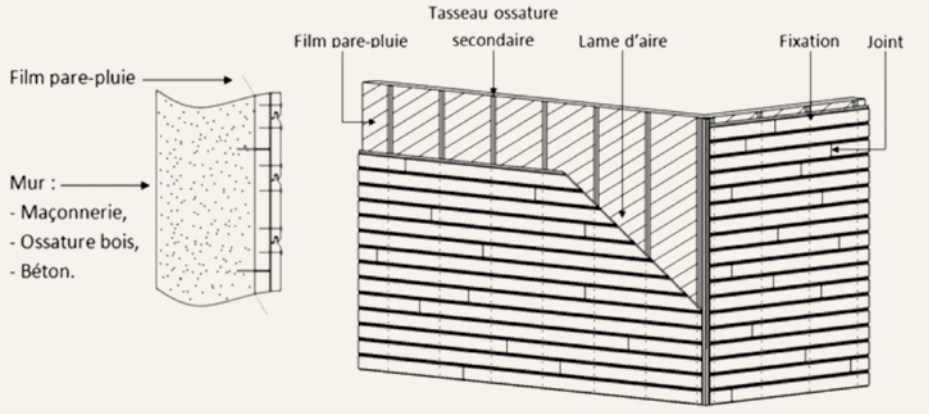

### Rainscreen film :

- Permeance:  $0.5 \text{ g/m}^2 \cdot \text{h} \cdot \text{mm} \cdot \text{Hg}$ ,
- Fixing by the battens,
- Horizontal overlap 50 mm,
- Vertical overlap 100 mm.

### Orientation of the boards :

Tongue always upwards if laid horizontally or tongue facing the prevailing wind if laid vertically.

### Joints:

DUCERF products are assembled by tongue and groove at the end. The joints can then be found between two battens.

### Precautions for low finishes:

- Distance between cladding and floor  $\geq 200 \text{ mm}$ ,
- Distance between cladding and masonry connection  $\geq 30 \text{ mm}$ ,
- Suggestion: install a rodent
- Suggestion: install an anti-rodent grid.

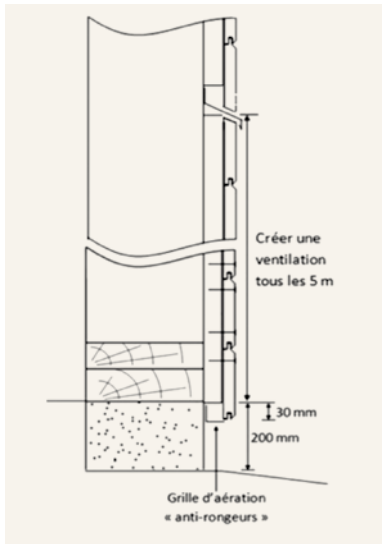

### Arrangement of the battens according to the direction of installation of the cladding boards :



Horizontal installation : vertical battens

Vertical installation : double battening

Vertical installation: staggered battens

### Planks: secondary framing :

#### Fixings :

- Stainless steel wood screws,
  - Stainless steel nails,
  - Doweling (concrete walls).
- Treatment: minimum class 3,  
Section: see table on the right.

#### Fixing the cladding :

- Screw with fillet under head (min. 22 mm),
- $\varnothing 3.5$  or 4 mm max, length depending on the thickness of the cleats,
- Penetration into the cleats :

centre distance of cleats (cm)	minimum cross-section of cleats (mm)	maximum distance between 2 fixings of the same cleat (cm)
30 (on a masonry wall)	15 x 35	30
40	22 x 40	40
60	27 x 40	60

22 mm min,

- Pre-drill the end of the blade to the diameter of the screw,

- Stainless steel fasteners,
- Self-drilling countersunk head screw,
- Number and location: see table:

Board width	Visible width	number and location of fastener(s)
100 mm	90 mm	1 visible fixing per support at approx. 15 mm from the bottom of the groove.
120 mm	110 mm	
140 mm	130 mm	2 visible fixings per support at 1/3 and 2/3 of the board width.

### Technical solution for outward facing corners, panel cladding :

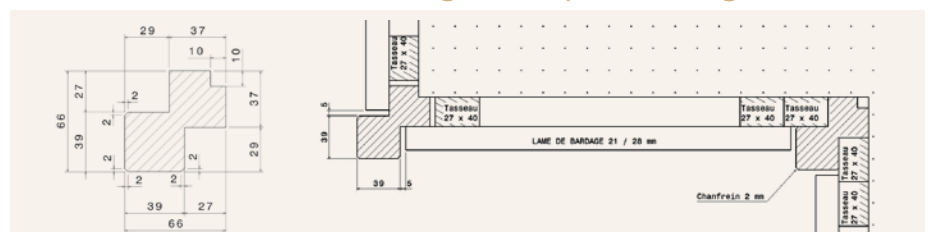

# DECKING

For standard profiles only, other cases: consult us.

The installation advice given above is indicative and non-contractual: it is a matter of usual and general rules to be respected, but it is not exhaustive; these rules must be completed and adapted on a case-by-case basis, according to the precise environment in which the products will be used. Installation by the customer assumes that he/she has the minimum technical skills to do so; if this is not the case, and in the event of any doubt or difficulty whatsoever, it is the customer's responsibility to consult a professional or your sales advisor before any intervention.

## Design advice :

**Joisting: characteristics :**  
Representation of a joist on planks :

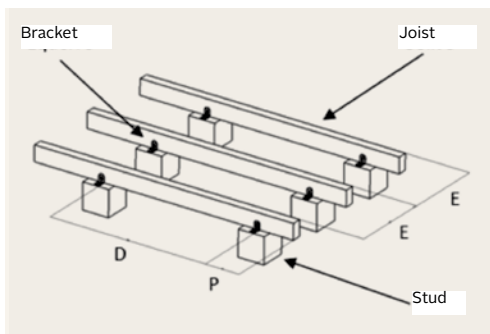

*P: max. overhang = 0.15 x D*  
*D: distance between studs*  
*E: joist centre distance*

The table below shows the recommended joist spacing (E) and stud spacing (D) depending on the joist cross-section:

Decking board	Section (mm)	Centre distance (mm)	Distance between studs (mm)
Oak / Ash THT / Acacia	65 x 40 mm Natural Oak 75 x 40 mm Oak THT	400	500
Oak / Ash THT / Acacia	63 x 43 mm Pine CL4 75 x 50 mm Pine CL4	400	600

Values for wood of strength class C18 / D18.

### Pre-drilling recommendation:

- Always for the blade,
- Carry out a countersink to insert the screw head,
- Pre-drilled diameter of 4 mm.

### Recommended screws for decking :

- Screws with undercutting,
- min. diameter 5 mm, min. length 50 mm
- Stainless steel screws required (A2 or A4)



## Technical sections for implementation

### Number of screws

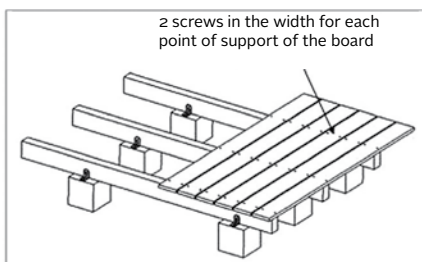

### Side overhang :

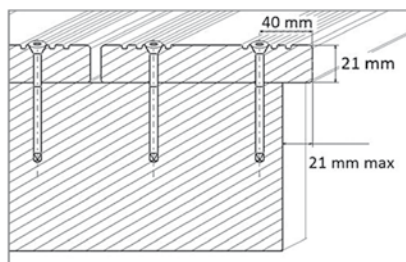

### Longitudinal overhang :

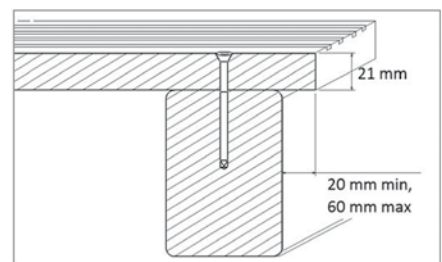

### Fixing the boards :

Cross section

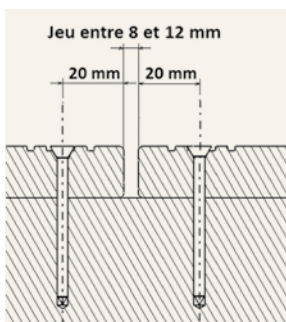

Boards gap :  
between 8 and 12 mm

### End joint: Longitudinal section

Recommendation: to improve the service life of the decking, prefer the solution ②

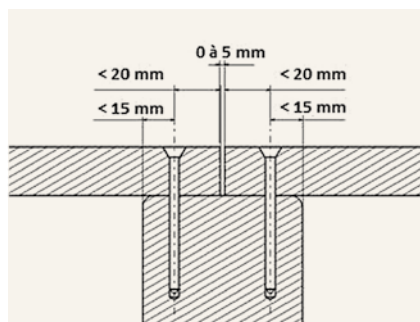

① Board end joint  
on a single support

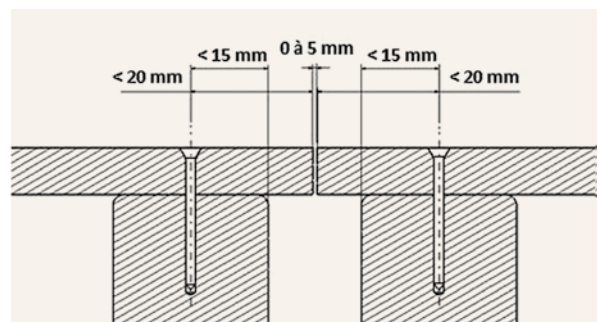

② Board end joint  
on double support

# CONVERSION TABLE

METRIC CONVERSIONS						
1 centimetre	=	10 millimetres	=	1 cm	=	10 mm
1 decimetre	=	10 centimetres	=	1 dm	=	10 cm
1 metre	=	100 centimetres	=	1 m	=	100 cm
1 kilometre	=	1000 metres	=	1 km	=	1000 m
IMPERIAL CONVERSIONS						
1 foot	=	12 inches	=	1 ft	=	12 in
1 yard	=	3 feet	=	1 yd	=	3 ft
1 chain	=	22 yards	=	1 ch	=	22 yd
1 furlong	=	220 yards (or 10 chains)	=	1 fur	=	220 yd (or 10 ch)
1 mile	=	1760 yards (or 8 furlongs)	=	1 mi	=	1760 yd (or 8 fur)
METRIC -> IMPERIAL CONVERSIONS						
1 millimetre	=	0.03937 inches	=	1 mm	=	0.03937 in
1 centimetre	=	0.39370 inches	=	1 cm	=	0.39370 in
1 metre	=	39.37008 inches	=	1 m	=	39.37008 in
1 metre	=	3.28084 feet	=	1 m	=	3.28084 ft
1 metre	=	1.09361 yards	=	1 m	=	1.09361 yd
1 kilometre	=	1093.6133 yards	=	1 km	=	1093.6133 yd
1 kilometre	=	0.62137 miles	=	1 km	=	0.62137 mi
IMPERIAL -> METRIC CONVERSIONS						
1 inch	=	2.54 centimetres	=	1 in	=	2.54 cm
1 foot	=	30.48 centimetres	=	1 ft	=	30.48 cm
1 yard	=	91.44 centimetres	=	1 yd	=	91.44 cm
1 yard	=	0.9144 metres	=	1 yd	=	0.9144 m
1 mile	=	1609.344 metres	=	1 mi	=	1609.344 m
1 mile	=	1.609344 kilometres	=	1 mi	=	1.609344 km

**1** “Les Bois Profilés” - UNIT 1  
F-71120 CHAROLLES

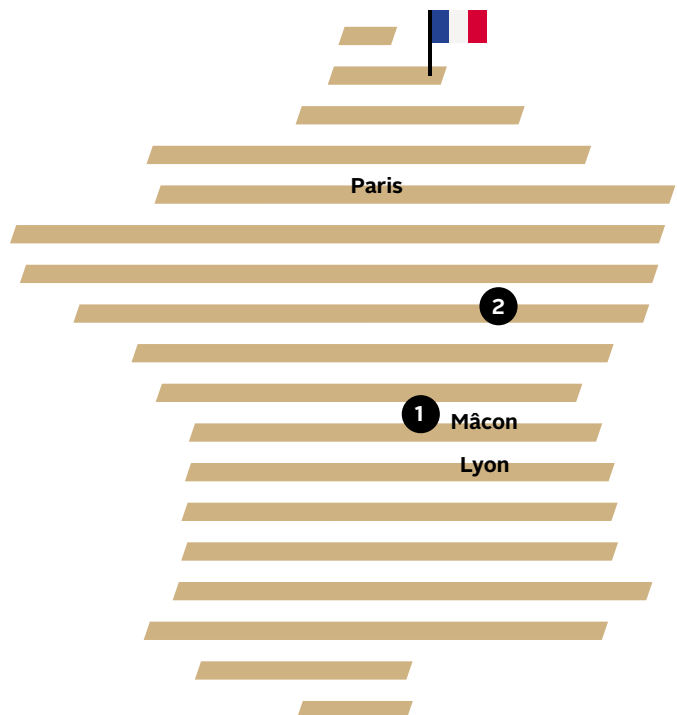

**2** “Bourgogne Bois Industrie” - UNIT 2  
F-21310 BEIRE-LE-CHÂTEL





In 1885, Jean Ducerf built his first sawmill in Burgundy, at the very heart of one of Europe's largest forest. Generation after generation, the family-owned group grew, spread, established new sites in France, implemented innovative processes and exported to many countries, while evolving with the market. At Ducerf, wood is considered holistically, together with all its applications. The group carries out the first and second transformation of various hardwood species, and mostly oak timber. Concerned about the environment, the family-owned business has adopted an ecologically responsible approach each day. A perfect way to lead by example and contribute to sustainable development. Today, Ducerf Group has become the leader in the timber industry, with very clear motivations: quality, innovation and passion.

Follow us on  
our social networks  
**in a click!**



19 avenue Joanny Furtin  
F-71120 Charolles  
**Commercial Team Export**  
Phone + 33 3 85 88 28 33  
Fax + 33 3 85 88 28 23

[www.ducerf.com](http://www.ducerf.com)

**LES BOIS  
PROFILES**  
Ducerf Groupe